



Pressure Wave Switches

Profiles, push buttons, pressure cells and ground sensors for automatic doors, gates and barriers

Maintenance free, robust, tried-and-tested

- **Very fast closing**
- **Pressure wave technology for a high standard of switching reliability**
- **Straightforward and robust structure**
- **Millions of units successfully in service**

Pressure wave switches

For automatic doors, gates and barriers

Can be used wherever a reliable switching pulse is required

The highly sensitive response of the pressure wave system means that it protects people and vehicles from almost all directions. The robustness and durability of the pressure wave switch make it an impressive opening sensor as well.

Quick and reliable

Even low pressure of 3 to 4 mbar is enough to guarantee the electric contact will switch. Pressure wave switch systems are well proven and maintenance free, as well as offering a particularly good cost-performance ratio.



Types of the D1 and D3 series

Technical data see back page, measurements in mm

D1 series – small and universal DW10

Pluggable pressure wave switch
Connections at bottom

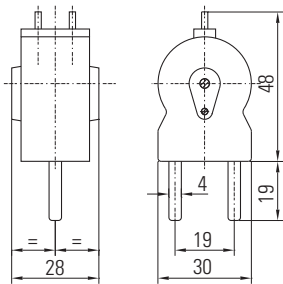

DW10s

Pluggable pressure wave switch
Connections on the side

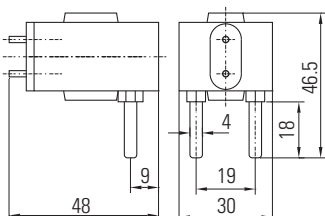

DW20s

Pressure wave switch with screw connections. Easily accessible screw terminals and 6.3 mm blade terminals

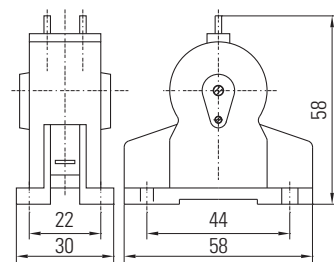

DW40

Pressure wave switch with connection terminals and 6.3 mm plug tab with clip-on mounting bracket

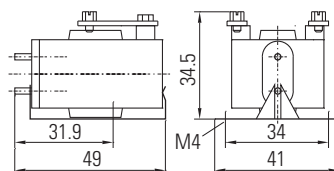

Types

- 209986 DW10
- 209999 DW10s
- 210004 DW20s
- 210018 DW40

D1 options e.g. for DW40

- 210018 DW40**
Pressure closes contact
- 210020 DW40D**
Pressure closes contact, sealed pressure equalisation valve

210025 DW40DOE

Pressure opens contact

D3 series – wide range use

Pressure wave switch with two-hole baseplate

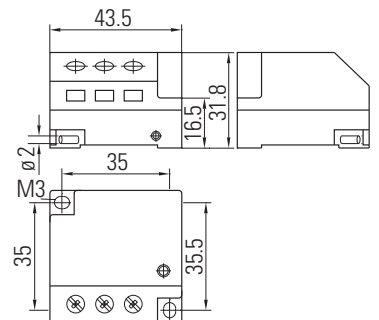

Types

- 209853 D3-P**
Pressure activates the binary switch
- 209854 D3-PB**
Pressure activates the binary switch, pressure equalisation valve is sealed (birottil)



Functional principles

A pressure wave generated by the sensor reaches the pressure wave switch. The membrane deflects and the electric contact switches.

The electric contact remains switched for as long as the input pressure is above the response pressure. With the contact (K) and valve screw (V) the switch's sensitivity can be set individually.

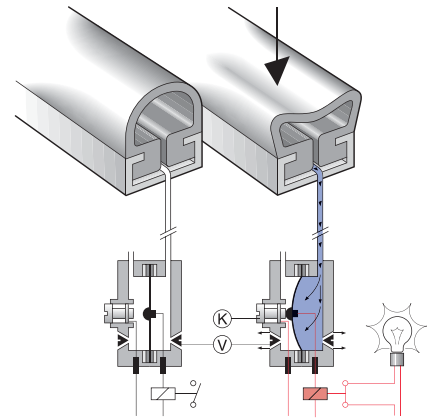

Reliable in every application

Situation

Bus door/Train door

Solution

- Safety: Pressure wave profile DWS

Advantages

- The pressure wave profile is very sensitive and switches quickly
- It protects against crushing and shearing, when the door is closing

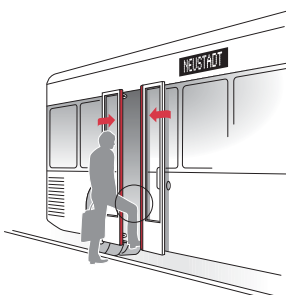

Situation

Roller gate

Solution

- Opening signal: Ground sensor DGU
- Safety: Pressure wave profile DWS

Advantages

- The ground sensor is very robust and can be driven over by all kinds of vehicles
- The pressure wave profile is very sensitive and switches quickly

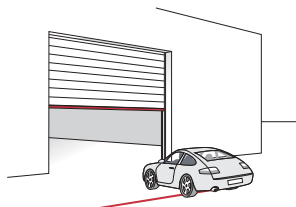

Situation

Barrier

Solution

- Opening signal: Ground sensor DGU
- Safety: Pressure wave profile DWS

Advantages

- The ground sensor is very robust and can be driven over by all kinds of vehicles
- The pressure wave profile is very sensitive and switches quickly

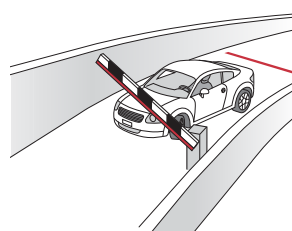

Situation

Sanitary area / explosive area

Solution

- Sensor: foot or hand-operated push button

Advantages

- Simple and safe control of electric switching procedures in damp rooms or rooms with a potentially explosive atmosphere



Pressure wave sensor

Pneumatic pressure wave profiles

Safety with profile

When a rubber profile gets an impact, the inside air volume is compressed pulsed and thereby generates a pressure wave. It passes through the connecting hose to the pressure wave switch, where it triggers a contact.

Order possibilities of the edges and rubber profiles

1. Fully assembled edge incl. of rubber and aluminium profile, e.g. DWS-C/1000 mm
2. Only rubber profile with pneumatic connections, e.g. DWSGUMMI-C/1000 mm
3. Made to measure rubber profile, e.g. DWSGO-C/1000 mm
4. Made to measure aluminium profile, e.g. DWSALU-C/1000 mm



Profile types

Technical data see back page, measurements in mm

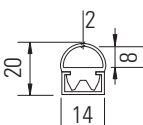
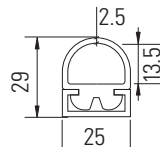
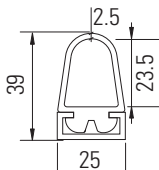
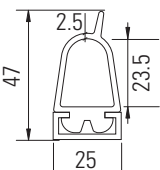
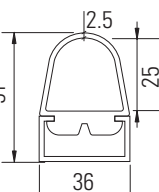
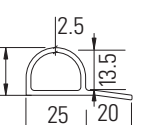
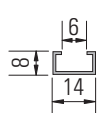
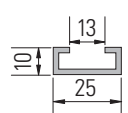
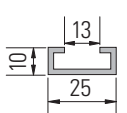
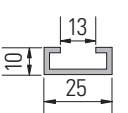
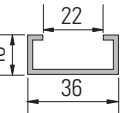
Dimensions						
	small air chamber	universal	universal + high	with sealing lip	big air chamber	adhesive
Rubber profile	DWS-D	DWS-C	DWS-B	DWS-Bs	DWS-A	DWS-P
Article no.	210173	210171	210167	210168	210165	210175
Material	PVC black	PVC black	PVC black	PVC black	PVC black	PVC black
Air cross section	77 mm ²	180 mm ²	400 mm ²	400 mm ²	550 mm ²	213 mm ²
Weight* with/without rail	0.27 kg/lfm / 0.14 kg/lfm	0.66 kg/lfm / 0.33 kg/lfm	0.75 kg/lfm / 0.42 kg/lfm	0.78 kg/lfm / 0.46 kg/lfm	1.3 kg/lfm / 0.8 kg/lfm	0.3 kg/lfm
Mounting Rail (Dimensions in mm)						
Aluminium profile	DWSALUD	AP-2	AP-2	AP-2	AP-1	
Article no.	210144	209577	209577	209577	209574	
Packaging unit	6 m	6 m	6 m	6 m	6 m	
End pieces	DWSED	DWSEC	DWSEB	DWSEB	DWSEA	DWSEC
Article no.	209154	208995	208996	208996	208997	208995

Pressure wave sensor

Pneumatic ground sensor / pressure cell / push button

Sensor for installation in the floor

The ground sensor DGU is principally used as a control signal transmitter in automatic door and gate opening systems. It is very robust and can be driven over by all kinds of vehicles. The pressure sensitive cell DGD is frequently used as a sensor in contact floors. It is extremely robust as well and is also popular because of its flat design and ease of installation.

Sensor for door and gate opening systems and for sanitary areas

Pneumatic foot and hand-operated push buttons are simple, robust sensors and are specifically suitable for damp rooms or rooms with a potentially explosive atmosphere. These tried-and-tested products are easy to install and offer reliable functions.



Ground sensor DGU*

Technical data see back page

Type selection

The DGU ground sensor is available in five standard overall lengths.

Standard overall length A in mm:

540, 1040, 1540, 2040, 3040

Standard effective length B in mm:

500, 1000, 1500, 2000, 3000

Installation

During installation care should be taken that the steel channel base is flush with the ground and only the ribbed part of the rubber profile projects above the surface.

Installation dimensions

in mm

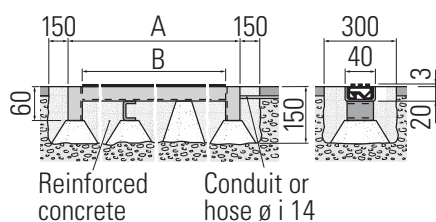

Pressure cell DGD*

DGD dimensions

in mm

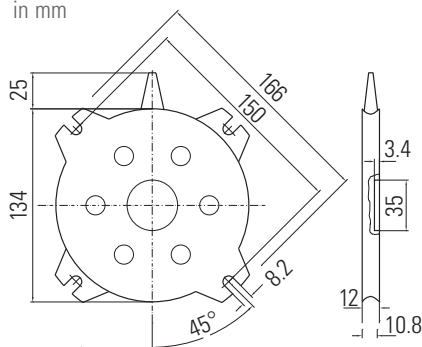

Specifications

- Max. pressure load 5 t / element
- Max. preload 40 kg / element
- Response weight ca. 5 kg / element
- Deformation 0.2 mm / 100 N
- Max. deformation 1.2 mm / 600 N
- Number of elements per system max. 8
- Operating temperature -20° to +70° C

Push buttons DT*

DT dimensions

in mm

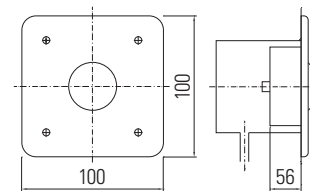

Foot-operated push button DTFU

Hand-operated push button DTFUW

- Visible plate made from chromium-nickel steel
 - Black push button bellows
- The DTFUW version is a handoperated push button and has an especially soft bellows.

Type

209979 DTFU
209981 DTFUW

Replacement part

209689 Bellows to DTFU
209690 Bellows to DTFUW

Pressure wave switches and sensors

Connection elements

Simplicity of connection

Pressure wave switches and sensors can be connected together easily and in a variety of ways. A wide range of connection pieces and hoses guarantees flexibility and reliable function appropriate to your application.



Connection elements

Measurements in mm

PVC 2/4

PVC air hose with 2/4 mm diameter, colour transparent

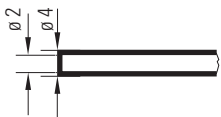

NEO 2/4

Neoprene air hose with 2/4 mm diameter, colour black, flame retardant

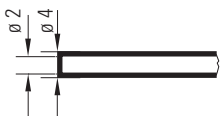

DWV

Straight air hose connection piece

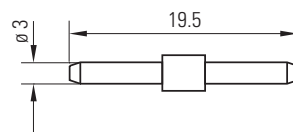

DWL

Air hose connection piece with L-shape

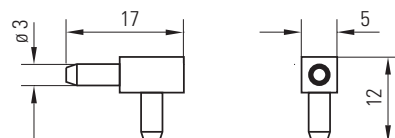

DWT

Air hose connection piece with T-shape

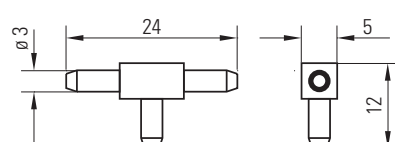

A3M5

Connection piece with two 3 mm diameter connections, thread M5

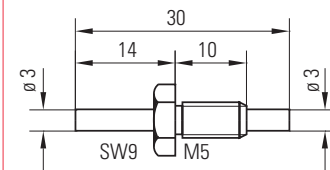

Pressure wave switches

Accessories

Maximum flexibility for installation

Install your pressure wave switches efficiently and compactly with a plug-in base. The practical housing made from impact-resistant plastic ensures protection against environmental influences according to IP54 or IP65.

Order possibilities

1. Separate housing, e.g. 212865 GEHDWGK1
2. Housing incl. of pressure wave switch, e.g. 210095 DWGK1



Plug-in base, cover hood and housing

Measurements in mm

DWSO plug-in base

- Space-saving and efficient installation of DW10 and DW10s
- Spring-mounted plugs
- Easily accessible connection terminals
- Ability to connect 6.3 mm blade terminals

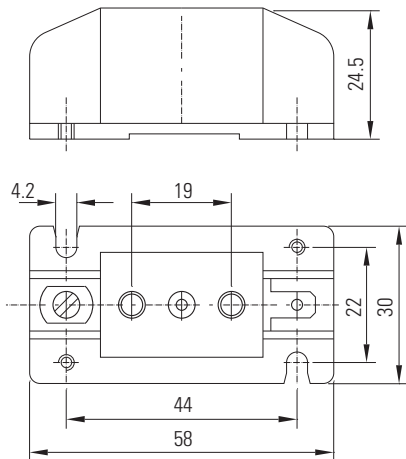

GEHDWGK 1

- Impact-resistant screw-on housing for pressure wave switch serie D1
- Protection class 65 (EN 60529)

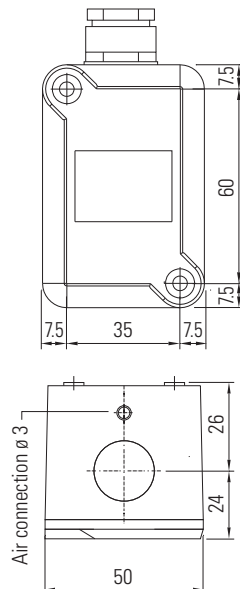

GEHDWGK 11/GEHD3K1

- Impact-resistant snap-in housing for pressure wave switch serie D1 and D3
- Protection class 54 (EN 60529)

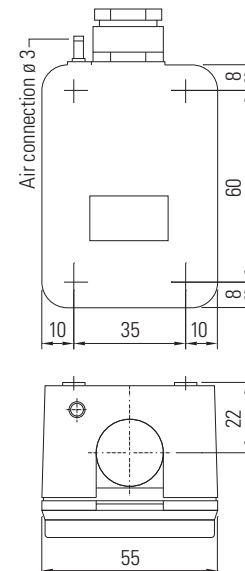

Ordering information

Ground sensor DGU

209932	DGU500	500 mm
209928	DGU1000	1000 mm
209929	DGU1500	1500 mm
209930	DGU2000	2000 mm
209931	DGU3000	3000 mm

Replacement rubber

209942	DGUG500
209935	DGUG1000
209936	DGUG1500
209937	DGUG2000
209941	DGUG3000



Pressure sensitive cell DGD

209926	DGD	DGD pressure sensitive cell
---------------	------------	-----------------------------



Pneumatic foot and hand-operated push buttons DT

209979	DTFU	Foot-operated push button DTFU
209689	B-DTFU	Bellows to DTFU
209981	DTFUW	Hand-operated push button DTFUW
209690	B-DTFUW	Bellows to DTFUW



Connection elements

207495	PVC 2/4	PVC air hose, transparent, 100 m
207502	NEO 2/4	Neoprene air hose, black, 100 m
208930	DWV	Straight air hose connection piece
208929	DWL	Air hose connection piece with L-shape
208928	DWT	Air hose connection piece with T-shape
208968	A3M5	Connection piece with two \varnothing 3 mm connections, thread M5



Accessoires

210191	DWSO	Plug-in base for DW10 and DW10s
212865	GEHDWGK1	Impact-resistant screw-on housing for pressure wave switch serie D1
212866	GEHDWGK11	Impact-resistant snap-in housing for pressure wave switch serie D1, grey housing bottom
212864	GEHD3K1	Impact-resistant snap-in housing for pressure wave switch serie D3, black housing bottom
210032	D1CLIP	Mounting bracket for DW40
213966	SPK3	Spiral cable 3 m, 4 x 0.5 mm ² , PU
239889	SPK5	Spiral cable 5 m, 4 x 0.5 mm ² , PU
213967	SPK-APD	Connection box, surface mount, 52 x 50 x 40 mm, material ABS



The rubber profiles can be joined to the end pieces by using Tetrahydrofuran that can be bought at your local chemical store.

Technical data

D1 series – DW10/DW10s/DW20s/DW40

Response pressure	2 mbar
Max. pressure	150 mbar
Pressure equalisation	110 ml/min. at 2 mbar
Min./max. current	20 mA/500 mA (ACDC ohmic)
Min./max. operating voltage	24–250 VAC, 24–50 VDC
Output	NC or NO
Mechanical service life	50 million switchings
Ambient temperature	–30°C to +70°C

D3 series – D3P/D3PB

Response pressure	2 mbar
Max. pressure	500 mbar
Pressure equalisation	65 ml/min. at 2 mbar
Min./max. current	1 mA/1000 mA (ACDC ohmic)
Min./max. operating voltage	6–250 VAC, 6–50 VDC
Output	Changeover switch
Mechanical service life	10 million switchings
Ambient temperature	–30°C to +80°C

Pneumatic pressure wave profiles

Material	PVC
Profile length	max. 6 m
Connection cable to PW	max. 10 m (\varnothing 2/4 mm)
Manufacturing tolerances	at 20°C
Width/height	\pm 2 mm
Length up to 1000 mm	\pm 3 mm
Length up to 2000 mm	\pm 5 mm
Length up to 4000 mm	\pm 9 mm
Length up to 6000 mm	\pm 15 mm

Ground sensor DGU

Material	U-profile: galvanised steel Rubber profile: EPDM
Connection cable to PW	max. 10 m (\varnothing 2/4 mm)
Loading capacity	max. 2 t
Drive-over speed	max. 30 km/h
Operating temperature	–20°C to +60°C

Housing GEHDWGK-1 / GEHDWGK-11

Material	Impact-resistant plastic, Luran 786R, grey or black
Fastening	2 x M4 screw
Electrical connection	PG-cable gland PG11
Air connection	Connection nipple \varnothing 3 mm
Protection class	IP 54 or IP 65 (EN 60529)

Note

Technical details and recommendations concerning our products are based on experience and are an aid for the orientation of the user. Details stated in our brochures and data sheets do not guarantee special properties of the products. This does not apply to special product properties confirmed by us in writing or individually. Subject to technical alterations.

BBC Bircher Smart Access

Wiesengasse 20
8222 Beringen
Switzerland
Phone +41 52 687 11 11
info@bircher.com
www.bircher.com